







EM9250

CompactLine

NEW

-  Digital Display
-  Fast Selection Program
-  Electrical Brake
-  Laser & Led Light OPT
-  AWD OPT



Premium Version





NEW

VISUALIZZAZIONE A DOPPIO DISPLAY
A DOUBLE DISPLAY CONTROL PANEL



RILEVAMENTO DIMENSIONI RUOTA
WHEEL DIMENSION DETECTION



POSIZIONAMENTO AUTOMATICO E
FRENO ELETTRICO
AUTOMATIC POSITIONING AND
ELECTRICAL BRAKE



NEW

AWC CALCOLO AUTOMATICO
DELLA LARGHEZZA
AWC - AUTO WIDTH CALCULATION



NEW

ILLUMINATORE LED E LASER
LED ILLUMINATOR AND LASER



NEW

RILEVATORE AWD
AWD - AUTO WIDTH DEVICE



EQUILIBRATRICE A DISPLAY COMPATTA ED ESSENZIALE CON PRESTAZIONI PROFESSIONALI
BALANCING WITH DISPLAY COMPACT AND ESSENTIAL WITH PROFESSIONAL PERFORMANCES

EQUILIBRATRICI DIGITALI AD ELEVATE PRESTAZIONI E SOFTWARE DI NUOVISSIMA CONCEZIONE

VERSIONI DISPONIBILI

EM9250 PREMIUM: versione con introduzione automatica di diametro e distanza ruota. Freno di stazionamento elettrico.

EM9250 PROFESSIONAL: versione con introduzione automatica di diametro e distanza ruota.

EM9250 BASIC: versione con introduzione manuale di diametro e distanza ruota.

Tutte le versioni sono normalmente fornite con protezione ruota e lancio automatico.

HIGH PERFORMANCE DIGITAL WHEEL BALANCER WITH LATEST GENERATION SOFTWARE SOLUTIONS

AVAILABLE VERSION

EM9250 PREMIUM: version with automatic input of wheel diameter and distance. Electrical clamping brake.

EM9250 PROFESSIONAL: version with automatic input of wheel diameter and distance.

EM9250 BASIC: version with manual input of wheel diameter and distance.

All models are normally supplied with automatic spin by pushing down wheel guard.

1 DISPLAY E PIANALE PORTAPESI / DISPLAY AND WEIGHT TRAY





 **Visualizzatore a doppio display (A)**, permette una selezione rapida ed intuitiva dei programmi di equilibratura e l'accesso immediato alle funzioni di lavoro più comuni.

Pianale portapesi (B) ergonomico e funzionale, dotato di ampie vaschette per le diverse tipologie di contrappesi e il posizionamento degli utensili.

 **A double display (A)** control panel enables a quick and intuitive selection of the balancing mode and immediate access to the most common operating functions. **Weight tray (B)** ergonomic and functional, it features many large tray to house all different types of weights and the various tools.

2 GRUPPO DI LANCIO / SPIN UNIT

 Gruppo di lancio derivato dai modelli superiori, fornisce caratteristiche di precisione e funzionalità tipiche di equilibratrici di fascia alta: tempo di ciclo ridotto, misura su ruote con peso fino a 75 kg ed equilibratura di ruote con offset interno fino a 275 mm senza l'utilizzo di distanziali aggiuntivi. L'innovativa motorizzazione a manutenzione zero ne assicura la massima affidabilità.

 Spin unit derives from the superior models of the B-Series and provides functional features typical of the upper models: reduced cycle time, measuring wheels weighing up to 75 kg and wheel balancing with inside offset of up to 275 mm without using additional spacer.

The innovative drive and zero maintenance ensure maximum reliability.

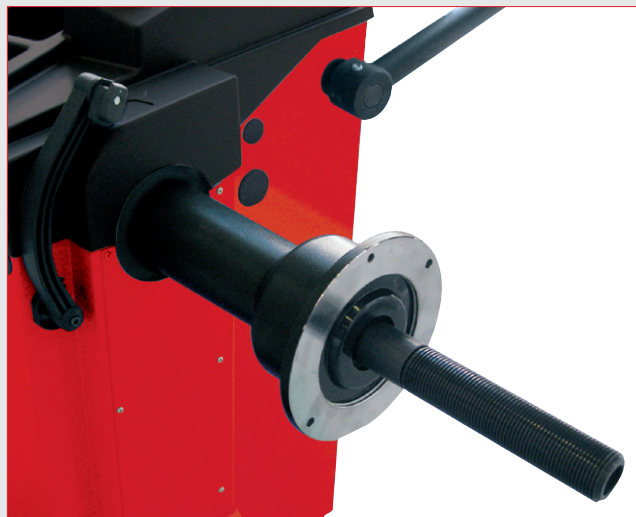

3 ACQUISIZIONE DATI RUOTA / WHEEL DIMENSION DETECTION

 **Acquisizione elettronica** di diametro e distanza con funzione FSP che attiva automaticamente i programmi di equilibratura evitando le selezioni da tastiera (*).

Tre sistemi per il posizionamento dei pesi adesivi: con clip portapesi (*), con indicatore laser a ore 6 (*) o manualmente a ore 12.

 **Electronic input** of wheel diameter and distance with FSP function which automatically activates the balancing programmes, avoiding keypad selection (*).

Three modes to position the adhesive weights: with the weight holder clip (*), with the 6 o'clock laser indicator (*) or manually at 12 o'clock.



4 POSIZIONAMENTO AUTOMATICO E ILLUMINATORE LED / AUTOMATIC POSITIONING AND LED ILLUMINATOR

 **Posizionamento automatico** della ruota nel punto di applicazione del peso di equilibratura (RPA) e freno di stazionamento elettrico (*).

L'illuminatore led illumina l'area di lavoro per facilitare le operazioni di pulizia del cerchione e l'applicazione dei contrappesi. I contrappesi possono essere posizionati con estrema velocità utilizzando il puntatore laser a ore 6 (*).

 **Automatic wheel positioning** in the point where the balancing weight has to be applied (RPA) and electrical positioning brake (*).

LED spotlight to light-up the work area and make it easier to clean the rim, check the wheel and apply weights. The adhesive weights can be positioned extremely rapidly using the **laser pointer** at 6 o'clock (*).

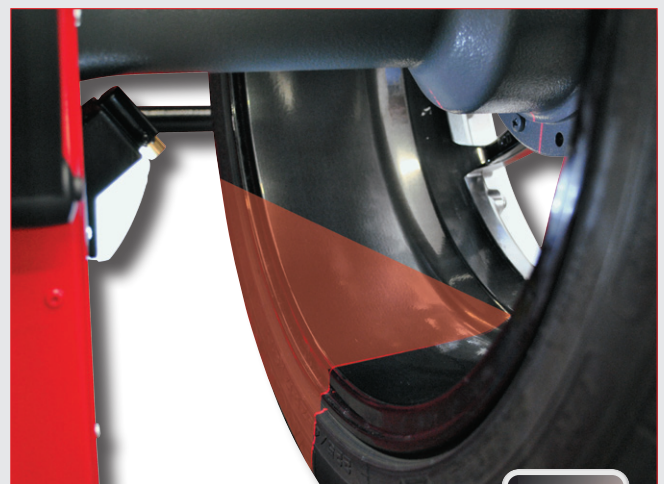

5 DISPOSITIVO SONAR AWD / AWD SONAR DEVICE (OPTIONAL)

NEW





 **Rilevatore AWD (Auto Width Device)** per la misura automatica della larghezza ruota senza contatto con sensore sonar (*).

 **AWD automatic sensor (Auto width Device)** for contactless measurement of wheel width (*).

6 FRENO DI BLOCCAGGIO / PEDAL WHEEL HOLDER (OPTIONAL)



 **Freno di bloccaggio** albero porta ruota a pedale, facilita le operazioni di bloccaggio e sbloccaggio ruota e l'applicazione dei contrappesi (*).

 **Pedal wheel holder** shaft locking brake, makes easier both the wheel clamping and unclamping options as well as the application of weights (*).

7 BASE CON PIEDE / SUPPORT BASE (OPTIONAL)

 **Piede** per equilibrare ruote fino a 50 kg di peso senza dover fissare la macchina al suolo

 **Front support base** for balancing wheels up to 50 kg. without fastening the machine to the ground.

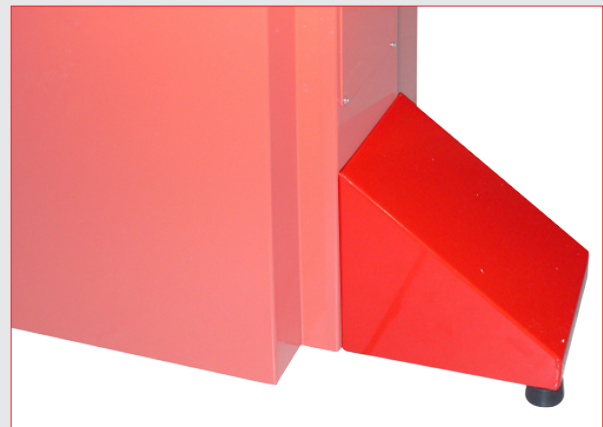

TUTTI I MODELLI / ALL MODELS



PESO NASCOSTO HIDDEN WEIGHT

Perfetta estetica del cerchio perchè permette di dividere il peso adesivo di equilibratura del fianco esterno in due pesi equivalenti collocati in posizione nascosta dietro le razze.

Keeps rims looking great by dividing the external side balancing adhesive weight into two equivalent weights applied in hidden locations behind the spokes.



OPT FLASH

Massima silenziosità di marcia perchè permette di ottimizzare la silenziosità variando la posizione del pneumatico sul cerchio.

Minimises road noise by allowing the operator to alter the position of the tyre on the rim in order to optimise quietness.

AWC - CALCOLO AUTOMATICO DELLA LARGHEZZA / AWC - AUTO WIDTH CALCULATION



Calcolo automatico della larghezza ruota (funzione AWC) anche in assenza del sensore esterno AWD

L'equilibratrice fa una previsione della larghezza ruota riducendo i tempi operativi (*).

Automatic calculation of the width (AWC function) even if the AWD external sensor is not present.

The wheel balancer calculates the width by reducing the operational time (*).

Programmi di utilità generale: calibrazione, servizio, diagnostica
General utility programs: calibration, servicing, self-diagnostic

* Funzione o accessorio a richiesta. Vedi tabella / Optional function or accessory. See diagram

MODELLO / MODEL	RPA	ELEC BRAKE	FSP	AWC	OPT EG1	OPT AWD	OPT LASER LED & LED LIGHT	OPT PEDAL BRAKE
EM9250 PREMIUM	✓	✓	✓	✓		✓	✓	
EM9250 PROFESSIONAL			✓	✓	✓		✓	✓
EM9250 BASIC								✓

Standard

Optional

Tensione di alimentazione	115÷230 V 1ph 50/60 Hz
Potenza complessiva assorbita	100 W
Velocità di lancio	90÷130 rpm
Valore max. di squilibrio calcolato	999 g
Risoluzione misura squilibrio	1 g 0,0353 oz
Tempo medio di misura	7 s
Diametro albero	40 mm 1,57"
Larghezza cerchio impostabile	1,5" ÷ 20"
Diametro cerchio impostabile	1" ÷ 35"
Diametro cerchio misurabile	10" ÷ 28"
Larghezza massima ruota (con protezione)	600 mm 23,6"
Diametro massimo ruota (con protezione)	1117 mm 44"
Distanza massima ruota/macchina	275 mm 10,82"
Peso ruota (fissaggio al suolo)	75 Kg
Peso macchina (senza accessori)	75 Kg

Power supply voltage	115÷230 V 1ph 50/60 Hz
Total power absorption	100 W
Spinning speed	90÷130 rpm
Max. unbalance value calculated	999 g
Unbalance measurement accuracy	1 g 0,0353 oz
Average measurement time	7 s
Shaft diameter	40 mm 1,57"
Rim width setting range	1,5" ÷ 20"
Rim diameter setting range	1" ÷ 35"
Rim diameter measurement range	10" ÷ 28"
Maximum wheel width (with guard)	600 mm 23,6"
Maximum wheel diameter (with guard)	1117 mm 44"
Maximum wheel/machine distance	275 mm 10,82"
Maximum wheel weight (ground fastening)	75 Kg
Machine weight (without accessories)	75 Kg

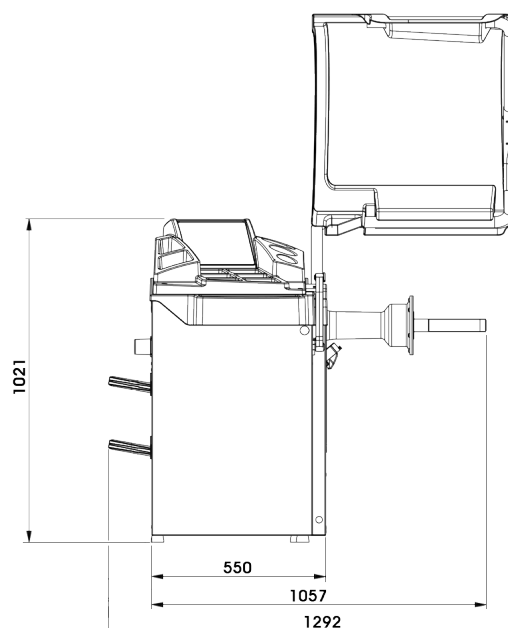
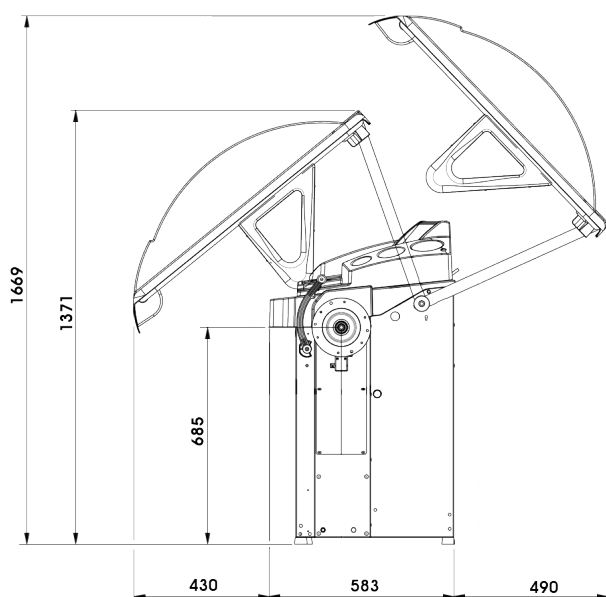
DIMENSIONI MASSIME - MAXIMUM DIMENSIONS

DOTAZIONE / STANDARD EQUIPMENT

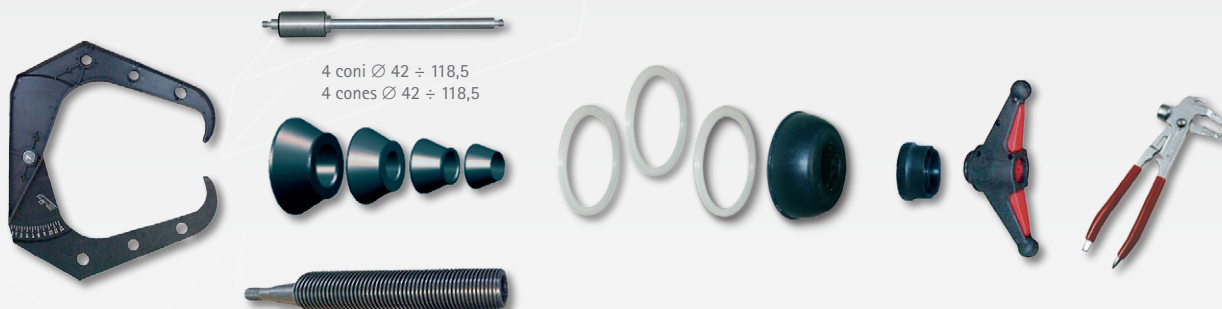

4 coni Ø 42 ÷ 118,5
4 cones Ø 42 ÷ 118,5

ACCESSORI CONSIGLIATI RECOMMENDED ACCESSORIES

- A** 8-21100141
DX/CBF Accessorio di centraggio per furgoni e fuoristrada con foro centrale Ø 117÷173 mm
DX/CBF Centring accessory for van and off-road wheels with central hole with Ø 117÷173 mm



- B** 8-21100191
CB Freno di bloccaggio albero porta ruota a pedale
CB Pedal wheel holder shaft locking brake

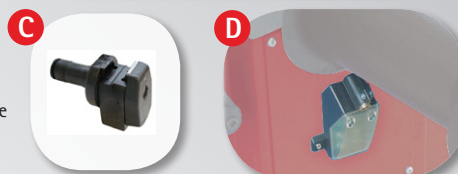

- C** 8-21100159
CLIP Terminale portapesi STD ALU
CLIP STD ALU weight-holder terminal

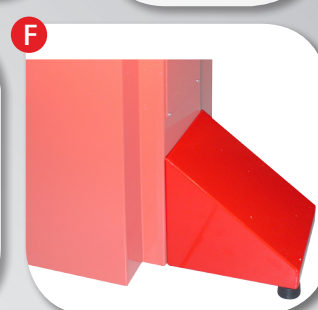
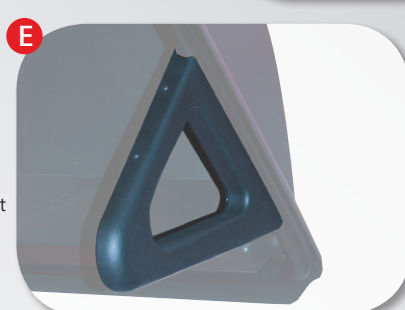

- D** 8-8-21100238
LL Kit illuminatore interno ruota a LED e puntatore LASER
LL kit Inside wheel LED light and LASER pointer kit

- E** 8-21100232
Rilevatore della larghezza AWD
AWD automatic sensor

- F** 8-21100158
PL50 Piede per equilibrare ruote fino a 50 kg senza fissare la macchina a terra.
PL50 Base for balancing wheels up to 50 kg without fastening the machine to the ground.

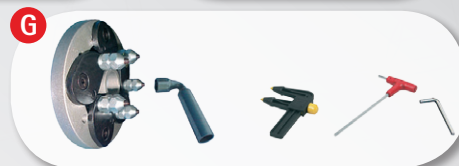

- G** 8-21100091
FRU Flangia autocentrante universale per ruote vettura senza foro centrale
FRU Universal self-centring flange for wheels without central hole



- H** 8-21100230
TT-0 Sollevatore effetto "Senza Peso"
TT-0 "Weightless effect" wheel lifter

Per maggiori informazioni consultare il catalogo accessori completo - For more information, please consult the accessories catalogue.

<http://www.facebook.com/CORGHISpa>



<https://twitter.com/corghispa>



<http://www.youtube.com/CORGHISpa>



CORGHI S.p.A. a NEXION GROUP COMPANY
Strada Statale 468 n° 9 - 42015 CORREGGIO - R.E. - ITALY
Tel. ++39 0522 639.111 - Fax ++39 0522 639.150 - www.corgchi.com - info@corgchi.com

