



ERCO X5000 ERCO X4300 SERIES



5t



4,3t



SOLLEVATORE ELETTROIDRAULICO a forbice



Scissor type *ELECTRO-HYDRAULIC LIFT*



ELEKTROHYDRAULISCHE Scherenhebebühne



ERCO X5000 - ERCO X4300 SERIES

Pedane piane oppure con piatti oscillanti

Flat runways or with slip plates

Flachen Schienen oder mit Schiebeplatten

Lift-Table

Pattini di scorrimento in materiale plastico

Plastic sliding shoes

Gleitböcke aus Kunststoff



Le cremagliere di stazionamento, per eseguire il **ciclo assetto**, sono registrabili; l'elettronica controlla che le cremagliere delle due pedane siano ingranate sullo stesso dente.

*To enable the wheel **alignment cycle**, the lift parking racks are adjustable; the electronics control whether the runways lift parking racks are engaged on the same teeth.*

Die Zugstangen für die Feststellung zur Ausführung des **Achsvermessungszyklus** sind einstellbar; die Elektronik steuert, dass die Zugstangen der beiden Schienen an dem selben Zahn eingreift sind.

VERSIONI DISPONIBILI
AVAILABLE VERSIONS
VERFÜGBARE VERSIONES

	ERCO X5000 SERIE												ERCO X4300 SERIE				
	ERCO X5000	ERCO X5000 CT	ERCO X5000 CT PT2	ERCO X5000 CT PT6	ERCO X5000 PT2	ERCO X5000 PT6	ERCO X5000 LT	ERCO X5000 CT LT	ERCO X5000 LT PT2	ERCO X5000 LT PT6	ERCO X5000 CT LT PT2	ERCO X5000 CT LT PT6	ERCO X4300	ERCO X4300 CT	ERCO X4300 PT2	ERCO X4300 PT6	ERCO X4300 CT LT
Pedane piane <i>Flat runways</i> Flachen Schienen	✓				✓	✓	✓		✓	✓			✓		✓	✓	
Lift-Table							✓	✓	✓	✓	✓						✓
Versione per assetto ruote <i>Wheel alignment version</i> Hebebühne für Achsvermessung		✓	✓	✓				✓						✓			✓
Prova giochi a 2 movimenti <i>2-movement play detector</i> Gelenkspieltester mit 2 Bewegungen			✓		✓				✓		✓				✓		
Prova giochi a 6 movimenti <i>6-movement play detector</i> Gelenkspieltester mit 6 Bewegungen				✓		✓				✓	✓					✓	

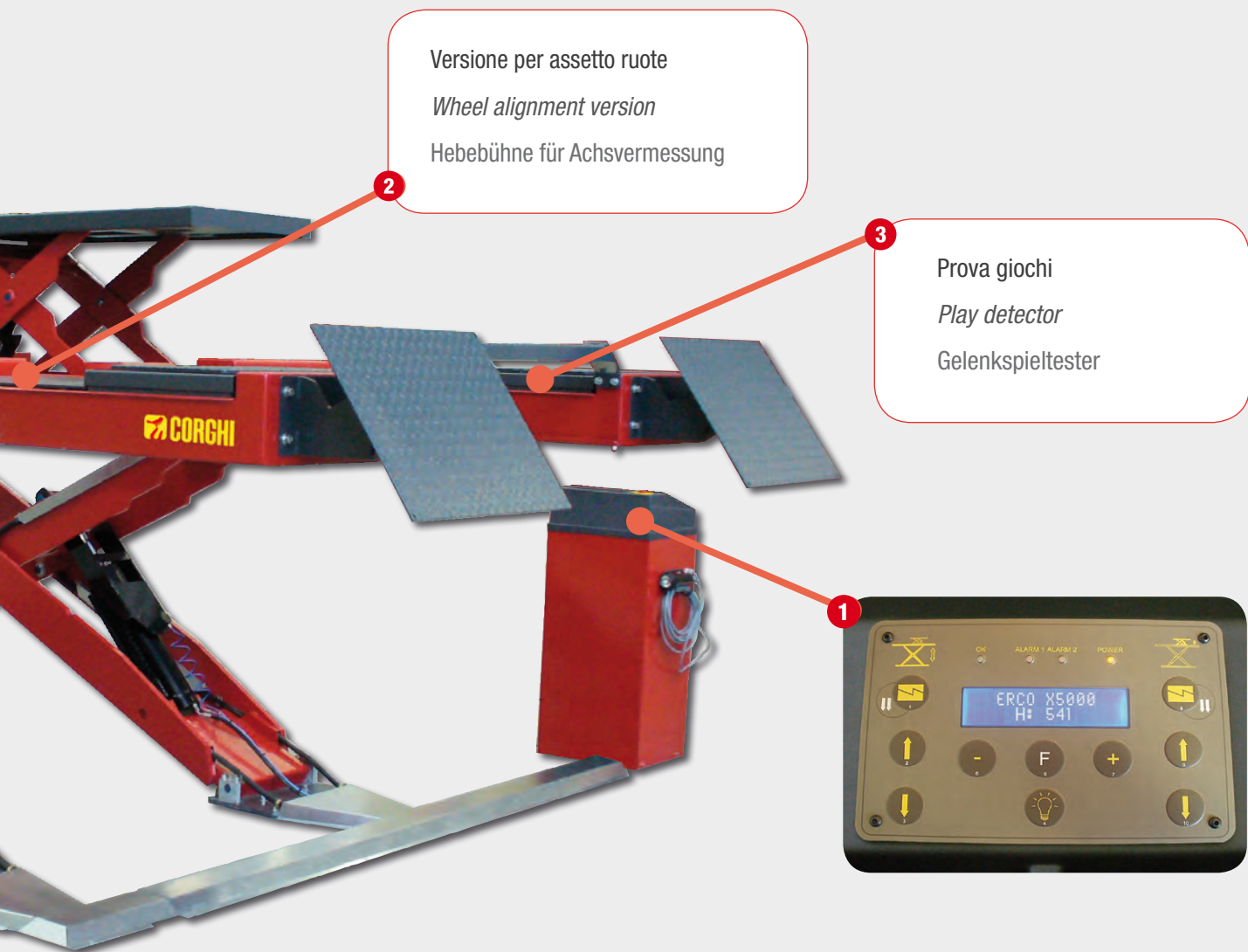

Versione per assetto ruote
Wheel alignment version
 Hebebühne für Achsvermessung

Prova giochi
Play detector
 Gelenkspieltester

1 DISPLAY

L'elettronica di controllo è dotata di un **DISPLAY ALFANUMERICO** con numerose funzioni per l'utente, fra cui la possibilità di visualizzare l'altezza del ponte e impostare l'arresto del sollevatore all'altezza desiderata.

*The control electronics feature an **ALPHANUMERIC DISPLAY** allowing access to a number of user functions, including viewing lift height from ground and setting the desired arrest height for the lift.*

Die Steuerelektronik verfügt über ein **ALPHANUMERISCHES DISPLAY** mit zahlreichen Benutzerfunktionen, wie der Möglichkeit, die Höhe der Hebebühne anzuzeigen und ein Anhalten der Hebebühne auf der gewünschten Höhe einzustellen.

2 VERSIONE PER ASSETTO RUOTE - WHEEL ALIGNMENT VERSION - HEBEBÜHNE FÜR ACHSVERMESSUNG

L'incavo piatti rotanti e le piastre oscillanti sono registrabili (operazione eseguita in fabbrica) per ottenere una perfetta planarità delle pedane.

The recesses for the turn plates and slip plates are adjustable (pre-set in factory) to ensure perfect planarity of the runways.

Die Aussparung für die Drehteller und die Schiebepplatten sind einstellbar (Einstellung im Werk durchgeführt), um eine vollkommene Ebenheit der Schienen zu erreichen.



3 PROVAGIOCHI - PLAY DETECTORS - GELENKSPIELTESTERS

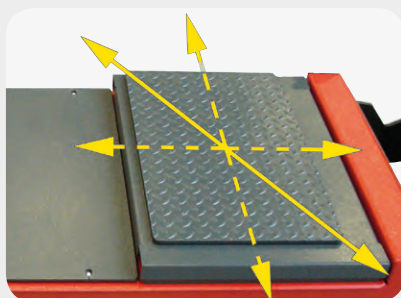

Sono disponibili **due versioni di provagiochi**, rispettivamente a due e sei movimenti (PT2-PT6). Le versioni con provagiochi a sei movimenti (PT6) possono essere dotate di comando senza cavo Wi-Fi.

*Two-movement and six movement **play detector versions** are available (PT2-PT6). Versions with the six movement play detector (PT6) are also available with Wi-Fi wireless control.*

Es sind **zwei Ausführungen des Gelenkspieltesters** mit jeweils zwei und sechs Bewegungen lieferbar (PT2-PT6). Die Ausführungen mit Gelenkspieltester mit sechs Bewegungen (PT6) können mit einer kabellosen Wi-Fi-Steuerung ausgestattet werden.

ERCO X5000 - ERCO X4300 SERIES

VERSIONI PER ASSETTO SENZA LIFT-TABLE - VERSIONS FOR WHEEL ALIGNMENT WITHOUT LIFT-TABLE
VERSIONEN FÜR DIE ACHSVERMESSUNG OHNE LIFT-TABLE

Nelle versioni per assetto senza lift-table l'asse anteriore del veicolo viene posizionato in un punto fisso del sollevatore (dove sono presenti i piatti rotanti), **indipendentemente dal passo del veicolo** e senza nessuna regolazione successiva.

*In the versions for wheel alignment without lift-table the vehicle's front axle is positioned in a lift's fixed point (where there are the turntables), **independently from the vehicle wheel base** and without any further regulation.*

Im Bereich den Versionen für die Achsvermessung ohne „Lift-Table“ die Vorderachse des Fahrzeuges wird in einem fixierten Punkt (wo die Drehteller liegen) positioniert, **unabhängig von dem Radstand** und ohne weitere Anpassungen.



CIRCUITO ELETTROIDRAULICO IN ANELLO CHIUSO - CLOSED LOOP ELECTROHYDRAULIC CIRCUIT
ELEKTROHYDRAULISCHE ANLAGE MIT GESCHLOSSENEM REGELKREIS GEWÄHRLEISTET

L'allineamento delle pedane è garantito da un **circuito elettroidraulico in anello chiuso**. Grazie alla gestione proporzionale dell'idraulica l'**allineamento delle pedane** si presenta privo di oscillazioni e costante durante tutta la corsa di sollevamento.

*The runways are kept correctly aligned by a **closed loop electrohydraulic circuit**.*

*Proportional hydraulic control ensures that, throughout the entire vertical travel, the runways move smoothly in **perfect alignment** and with no oscillation.*

Die Ausrichtung der Schienen wird durch eine **elektrohydraulische Anlage mit geschlossenem Regelkreis** gewährleistet. Dank der Proportionalsteuerung der Hydraulik ist die **SchienenAusrichtung** während der gesamten Hubfahrt schwingungsfrei und konstant.

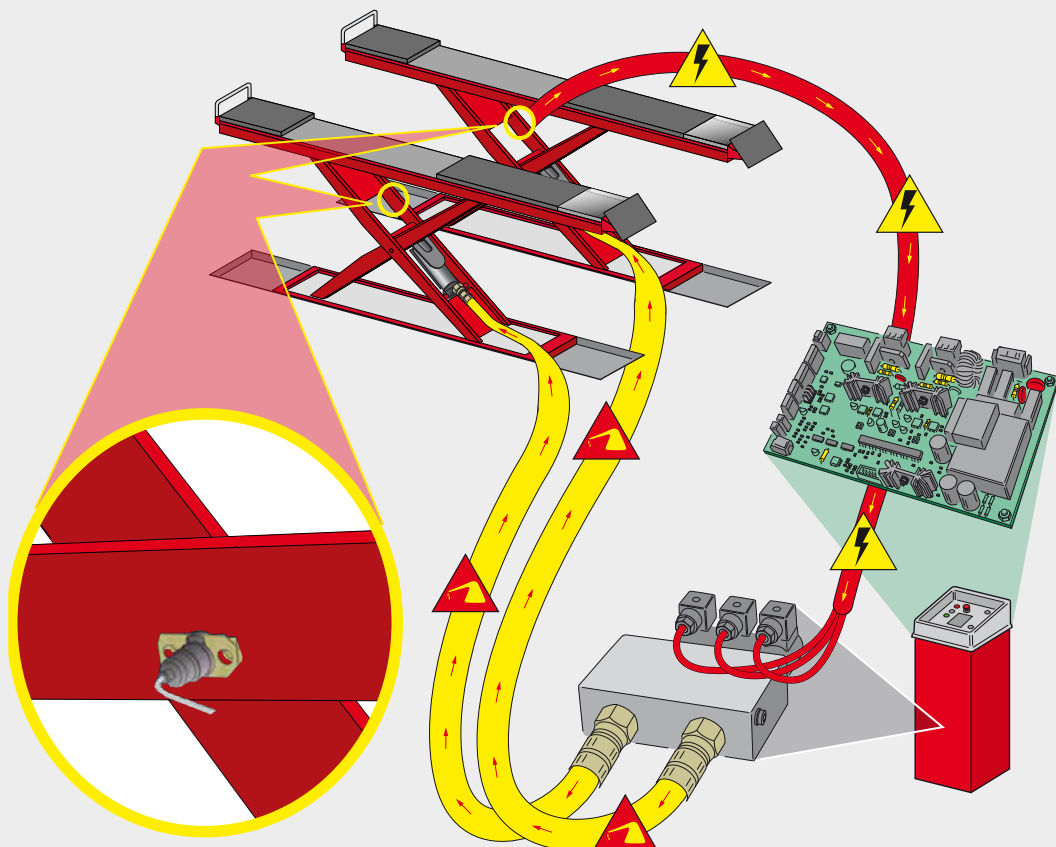

ERCO X5000 SERIE

DIMENSIONI - DIMENSIONS - ABMESSUNGEN

ERCO X5000

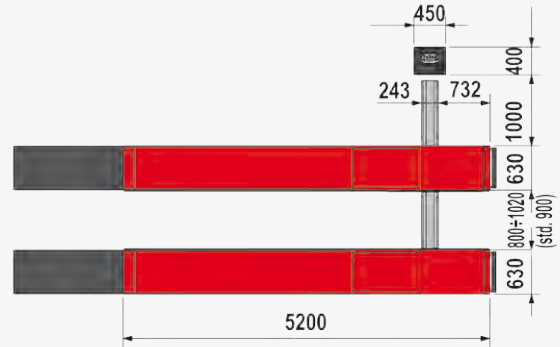
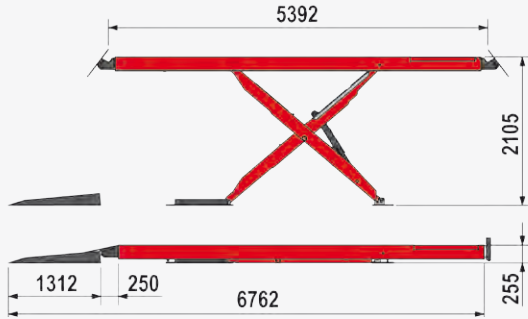

ERCO X5000 CT

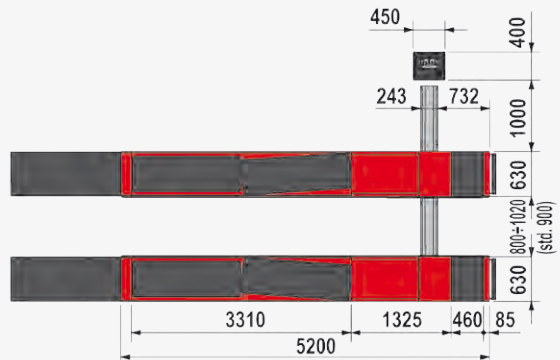
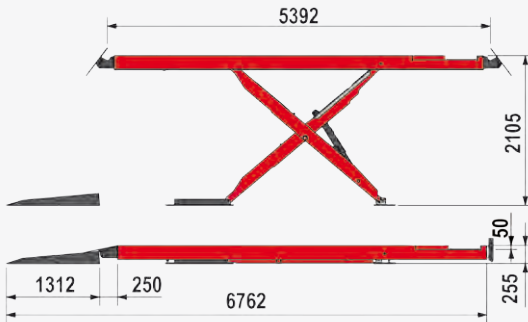

ERCO X5000 CT PT

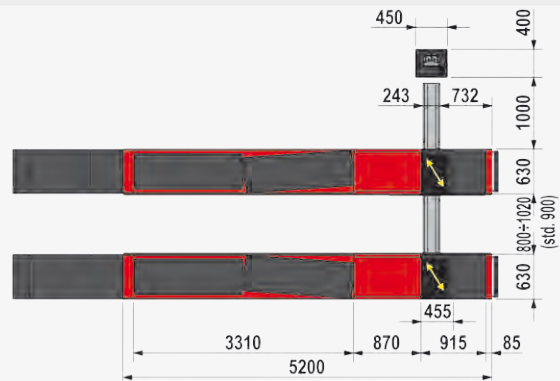
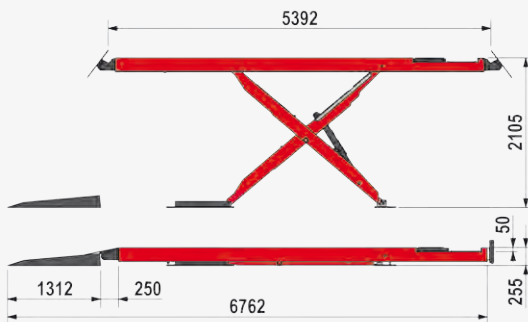

ERCO X5000 PT

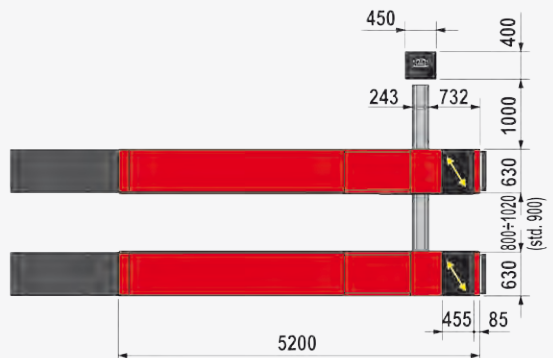
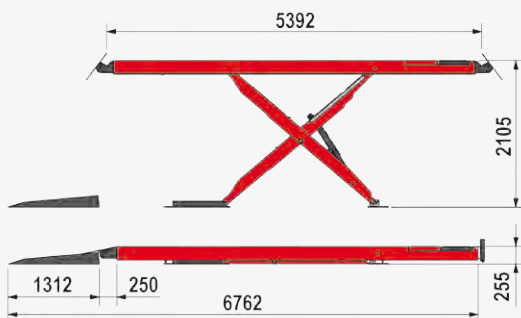

ERCO X5000 SERIE

DIMENSIONI - DIMENSIONS - ABMESSUNGEN

ERCO X5000 LT

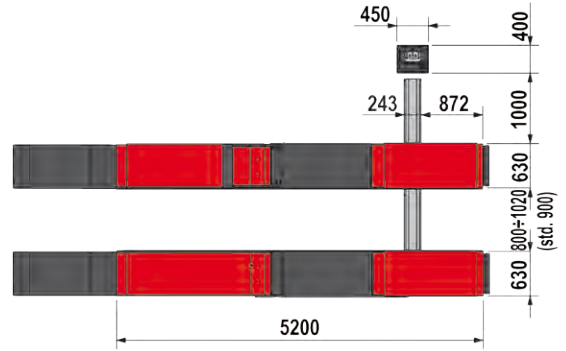
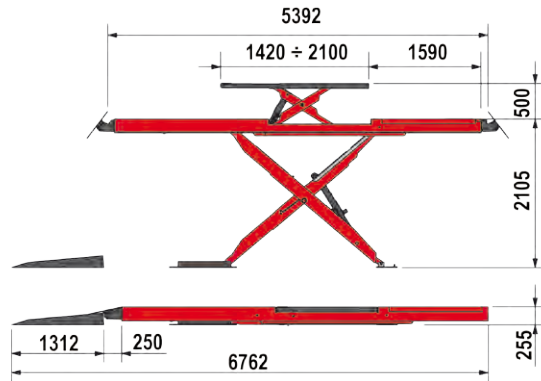

ERCO X5000 CT LT

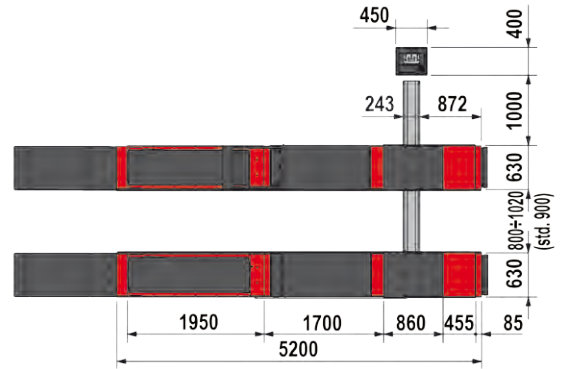
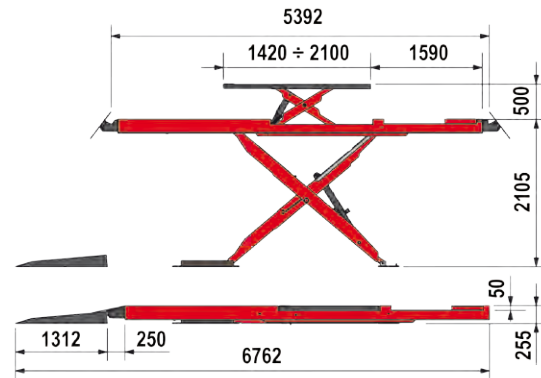

ERCO X5000 LT PT

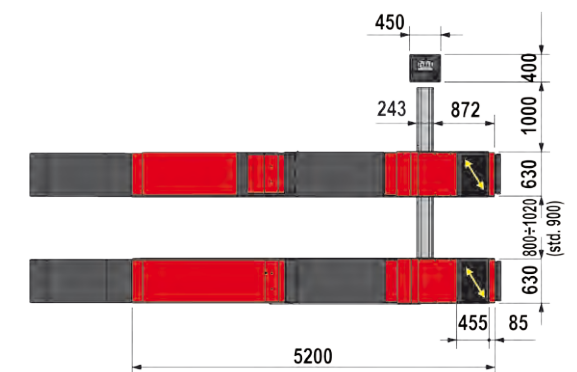
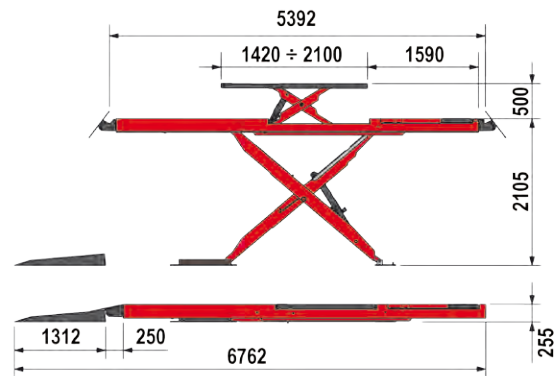

ERCO X5000 CT LT PT

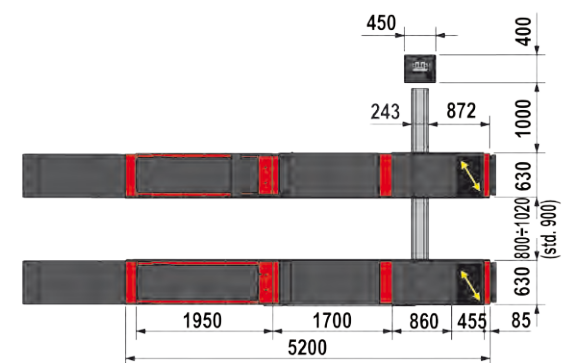
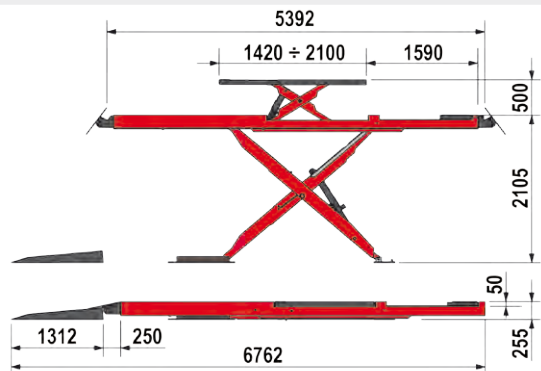

ERCO X4300 SERIE

DIMENSIONI - DIMENSIONS - ABMESSUNGEN

ERCO X4300

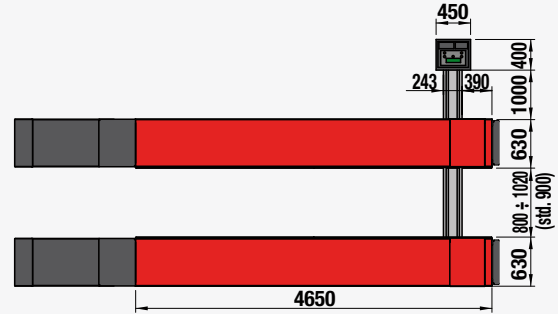
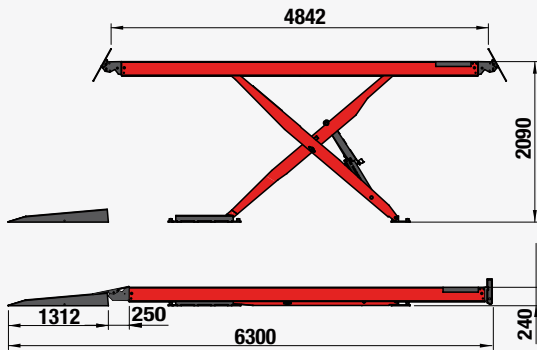

ERCO X4300 CT

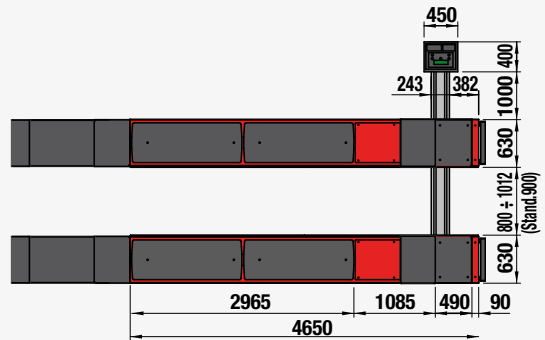
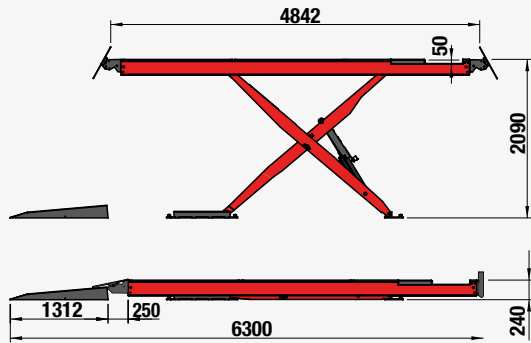

ERCO X4300 PT

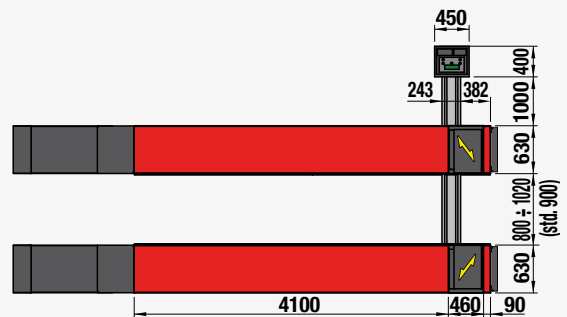
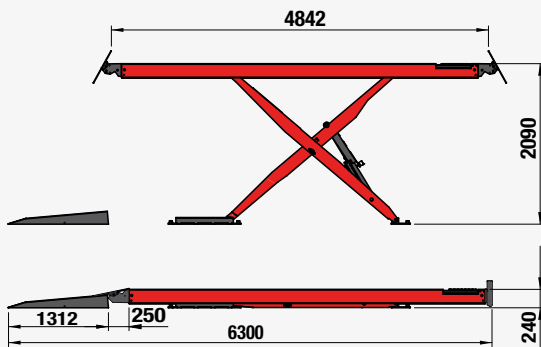

ERCO X4300 CT LT

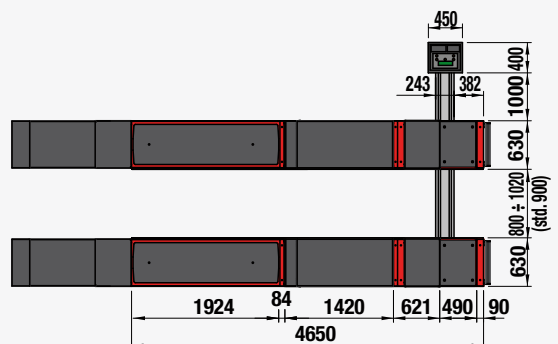
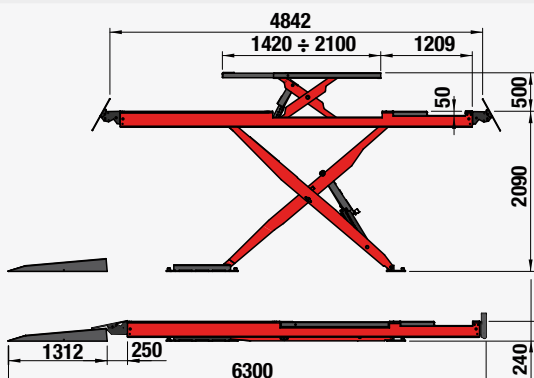

DATI TECNICI - TECHNICAL DATA - TECHNISCHE DATEN

Portata max.	Max. capacity	Max. Tragfähigkeit	5000 kg / 4300 Kg
Tempo di salita / discesa **	Lifting / lowering time **	Hubfahrt- / Senkfahrdauer **	95"
Alimentazione pneumatica	Pneumatic power supply	Druckluftversorgung	4-10 bar
Potenza motore	Motor power	Motorleistung	3 kW
Alimentazione	Power supply	Stromversorgung	230/400V - 3ph - 50Hz
Portata max. LT	Max. capacity LT	Max. Tragfähigkeit LT	3500 kg
Tempo di sollevamento LT	Lifting time LT	Hubfahrdauer LT	8"

** per i ponti con provagiocchi sono disponibili due versioni; la versione FAST è conforme MTCT, tempo di salita/discesa 60". Questa versione è disponibile solo a 400V-3ph-50Hz. ** two different versions available for lifts with play detectors; the FAST version is MTCT compliant, ascent/descent time 60". This version is available only for 400V-3ph-50Hz power. ** für die Hebebühnen mit Gelenkspieltester sind zwei Ausführungen lieferbar: die Ausführung FAST ist MTCT-konform, Hubfahrt-/Senkfahrdauer 60". Diese Ausführung ist nur mit 400V-3Ph-50Hz lieferbar.

ACCESSORI CONSIGLIATI - RECOMMENDED ACCESSORIES - EMPFOHLENES ZUBEHÖR

- A** **8-42300030**
Kit rampe a terra extra lunghe
Extra long grounded ramp kit
Kit Bodenrampen extra lang
chiusure / closed / geschlossen = 1120 mm
aperte / open / offen = 1920 mm
intermedia / intermediate /
Zwischenlänge = 1520 mm
- B** **8-42300060**
Kit illuminazione / Lighting kit
Beleuchtungskit
- C** **8-42300063**
Kit rampe appese / Suspended ramp kit
Kit Hängerampen L = 1800 mm
- D** **8-42120016**
Kit telaio per incasso (2 pz)
Frame kit for pit installations (2 pieces)
Kit Rahmen zum Versenken (2 Stück)
lunghezza / length / Länge = 5210 mm
larghezza / width / Breite = 815 mm
altezza / height / Höhe = 320 mm
- E** **8-42300047**
Coppia di traverse per fuoristrada
Pair of cross-pieces for off-road vehicles
Querträgerpaar für Geländewagen
L=1800 mm
- F** **8-33100101**
Piatti rotanti / Turn plates / Drehteller
- G** **8-42100015** KTPI-22
Kit traversa pneumatico-idraulica 2.2 t
Hydropneumatic transom kit, 2.2 t
Kit pneumohydraulischer Querträger 2.2 t
- H** Kit prolunga tubi
Pipe extension kit
Rohrverlängerungskit

- 8-42300095** L= 4m
8-42300097 L= 4m
8-42300094 L= 4m
8-42300100 L= 2m
8-42300102 L= 2m
8-42300099 L= 2m

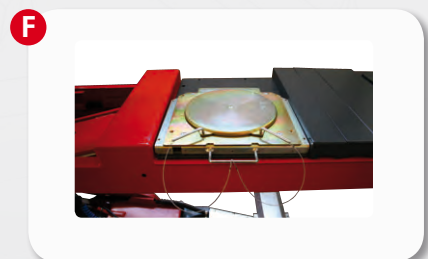
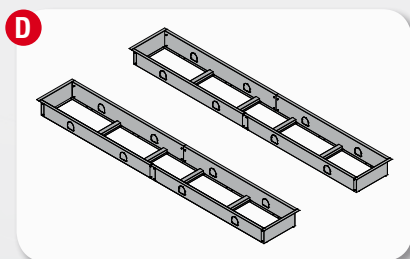

watch
Lifting
Equipment
Showroom



Per maggiori informazioni consultare il catalogo accessori completo.
For further information, consult the complete accessories catalogue.

Für weitere Informationen schlagen Sie bitte im Gesamtkatalog des Zubehörs nach.



NEXION SPA - ITALY - Società unipersonale soggetta a direzione e coordinamento di Minio srl - A sole shareholder Minio company

www.corghi.com - info@corghi.com



Per aiutare il pianeta ottimizzando il consumo di carta, i nostri cataloghi sono consultabili sul sito www.corghi.com. Una stampa responsabile aiuta a preservare l'ambiente. To protect the planet and reduce paper usage, our catalogues are viewable online at the website www.corghi.com. Printing responsibly contributes to saving the environment.

Fotografie, caratteristiche ed i dati tecnici non sono vincolanti, possono subire modifiche senza preavviso. The manufacturer reserves the right to modify the features of its products at any time. Les photographes, les descriptions et les données techniques ne sont pas contraignantes. Le fabricant se réserve le droit d'apporter des modifications sans préavis. Die Fotografien, die angegebenen Eigenschaften und die technischen Daten sind nicht verbindlich und können ohne Vorankündigung geändert werden. Fotos, charakteristische y datos técnicos no son vinculantes, pueden estar sujetos a modificaciones sin previo aviso. As fotografias, as características e os dados técnicos não são vinculantes, podem ser modificados sem prévio aviso. Code: DP66000797A 01/2018

